



Model PRO9056C
Installation Manual
Vehicle Remote Start System

Table Of Contents:

| | |
|------------------------------------------------------------|----------------|
| Before You Begin | Page 2 |
| Wire Harnesses Quick View | Page 3 and 4 |
| Installation Of The Major Components | Page 5 |
| Wiring The 6 Pin Main Power Harness | Page 5 and 6 |
| 12 Pin Accessory Input/Output Harness Wiring | Page 7 - 9 |
| Wirng the 4 Pin Auxiliary Output Harness | Page 10 |
| Connecting The Antenna/Receiver Program Switch/LED | Page 10 |
| 2 Pin Transponder Control Output | Page 11 |
| Engine Monitoring Selections, (Voltage Tach, DBI, Hybrid,) | Page 11-12 |
| Tachometer Programming | Page 11 and 20 |
| Diagnostics Mode | Page 12 |
| Multi Coil Pack Adaptor (Optional) | Page 12 |
| Hood Pin Safety Shut Down | Page 13 |
| Remote Start Override Mode (Manual Shut Down) | Page 13 |
| Neutral Start Safety Test | Page 14 |
| Mechanical Neutral Safety Switch Wiring Where Used | Page 15 |
| Key In Sensor Circuits | Page 15 - 17 |
| Completing The Installation | Page 17 |
| Programing Bank 1 (Transmitters) | Page 18 |
| Program Bank 2 (Alarm Features) | Page 18 - 19 |
| Program Bank 2 Feature Selections | Page 19 |
| Program Bank 3 Entry Mode | Page 20 |
| Program Bank 3 Feature Selections | Page 21 |
| Wiring Diagram | Page 22 |
| Notes | Page 23 and 24 |

PATENTED: www.voxxintl.com/company/patents

Before You Begin

PROFESSIONAL INSTALLATION IS STRONGLY RECOMMENDED

Roll down window to avoid locking the keys in the vehicle during installation.

Avoid mounting components or routing wires near hot surfaces or near moving parts like the steering wheel as it may prevent proper operation of the vehicle.

Tape or loom wires under the hood and dash for protection as well appearance.

Use grommets when routing wires through metal surfaces to prevent chafing and shorting.

Use a Digital Multi Meter for testing and verifying circuits. **DO NOT USE A "TEST LIGHT" OR "COMPUTER SAFE PROBE"** as these can set off air bags or damage sensitive vehicle computers and electronics.

**For technical support go to www.prestigecarsecurity.com
or call 1 800 225 6074**

This device complies with FCC Rules Part 15 Operation is subject to the following two conditions

(1) This device may not cause harmful interference and
(2) This device must accept any interference that may be received, including interference that may cause undesired operation.

NOTE:The manufacturer is not responsible for any radio or TV interference caused by unauthorized modifications to this equipment. Such modifications could void the user's authority to operate the equipment.

12 Pin Main Wiring Harness #1123751

| | | |
|----|---------------|---------------------------------------|
| 1 | Yellow/Black | (+) Output To Control Factory Alarm |
| 2 | Green/Orange | Tachometer Input |
| 3 | Black | Chassis Ground |
| 4 | Gray/Black | Negative Inhibit Shutdown Input (-) |
| 5 | Light Blue | Ground Output While Running (-) 300mA |
| 6 | Green/Yellow | Diesel Wait To Start Input |
| 7 | Gray | Shutdown Input (-) |
| 8 | No Connection | |
| 9 | Brown | Positive Inhibit Shutdown Input (+) |
| 10 | Brown/Black | Brake Shutdown Input (+) |
| 11 | White | Parking Light Output |
| 12 | White | Parking Light Input |

6 Pin Power / Start Harness #1123742

| | | |
|---|-----------|---------------------|
| 1 | Purple | Accessory (+) |
| 2 | Blue | Ignition 1 (+) |
| 3 | Red | Battery 2 - 12V (+) |
| 4 | Red/White | Battery 1 - 12V (+) |
| 5 | Yellow | Starter Output |
| 6 | Green | Ignition 2 (+) |

4 Pin Alternate Output Harness #1122585

| | | |
|---|--------------|-----------------------------------------|
| 1 | Black/Blue | Factory Disarm / Pulse Before Start (-) |
| 2 | Black/Green | Factory Arm / Pulse After Start (-) |
| 3 | Black/Red | Pulse After Shutdown (-) |
| 4 | Black/Yellow | Pulse During Crank (-) |

2 Pin Transponder Output Harness #1123292

| | | |
|---|-------|--------------------------------|
| 1 | Red | Battery (+) 100mA |
| 2 | Black | (-) Output While Running 100mA |

5 Pin Antenna Harness

Part # 1123906

This Remote Start/Alarm System is designed to be used with **Automatic Transmission- Fuel Injection Gas or Diesel Vehicles Only!**

INSTALLATION OF THE MAJOR COMPONENTS:

CONTROL MODULE: PART # 1365038

Select a mounting location inside the passenger compartment (up behind the dashboard). The mounting location selected must be within 24" of the ignition switch wiring harness to allow connection of the 6 pin main wiring harness. Be certain that the chosen location will not interfere with proper operation of the vehicle. Avoid mounting the module to or routing the wiring around the steering shaft/column, as the module or wiring may wrap around or block the steering wheel preventing proper control of the vehicle. The module will be secured after all wiring is completed which will allow complete access until the job is done. **Do Not Mount The Module In The Engine Compartment**, as it is not waterproof.

HOOD PIN SWITCH: PART # 1363699

The pin switch included in this package is intended for protecting the hood area of the vehicle. In all cases, the switch must be mounted to a grounded metal surface. When the pin switch is activated, (hood open), it will supply a ground to the input wire activating the alarm. In addition, the hood switch is required for the safety shut down of the remote start unit. If the vehicle is being worked on, this hood switch prevents the remote start activation even if the RF command to start is issued. **This switch must be installed in all applications. Failure to do so may result in personal injury or property damage.**

THE PUSH-BUTTON PROGRAM SWITCH/LED/RECEIVER/ANTENNA: PART # 1181202

The Superheterodyne Receiver Antenna Assembly provided with this unit allows routing from below the dash board for maximum operating range. Choose a location above the belt line (dashboard) of the vehicle for best reception. Special considerations must be made for windshield glass as some newer vehicles utilize a metallic shielded window glass that will inhibit or restrict RF reception. In these vehicles, route the antenna toward a rear window location for best reception. Secure the antenna with double stick tape provided.

IMPORTANT!

DO NOT PLUG THE SIX PIN MAIN POWER HARNESS OR THE MULTI PIN INPUT / OUTPUT HARNESS INTO THE CONTROL MODULE UNTIL ALL CONNECTIONS TO THE VEHICLE HAVE BEEN MADE. AFTER SELECTING YOUR TARGET WIRES AS DEFINED BELOW, DISCONNECT THE NEGATIVE BATTERY CABLE FROM THE VEHICLE BATTERY PRIOR TO MAKING ANY CONNECTIONS.

Note: Do not remove the fuse holders from this wire harness. Fuses must be used and located as close as possible to the power source for adequate protection of the vehicle.

WIRING THE 6 PIN MAIN POWER HARNESS: PART # 1123742

Note: Do not remove the fuse holders from this wire harness. Fuses must be used and located as close as possible to the power source for adequate protection of the vehicle.

1 VIOLET Wire: Accessory Output

Connect this wire to the Accessory wire from the ignition switch. This wire will show + 12 volts when the ignition switch is turned to the "ACCESSORY" or "ON" and "RUN" positions, and will show 0 volts when the key is turned to the "OFF" and "START" or "CRANK" positions.

2 BLUE Wire: Ignition 1 Output

Connect this wire to the ignition 1 wire from the ignition switch. This wire will show +12 volts when the ignition key is turned to the "ON" or "RUN" and the "START" or "CRANK" positions, and will have 0 volts when the key is turned to the "OFF" and "ACCESSORY" positions.

For Diesel Applications, this wire must be connected to the ignition circuit that powers the glow plugs if the vehicle requires glow plug pre-heating. (See selectable feature Bank 3 #11)

3 Fused RED WIRE: + 12 Volt Battery 2 Source

Locate the vehicle battery wire (s) at the ignition switch. Verification: These wires will register voltage in all positions of the ignition switch. Connect the Red wire to the vehicle's battery wire. This wire provides power for the start relay and the accessory relay.

4 Fused RED/WHITE WIRE: + 12 volt Battery 1 Source

Locate the vehicle battery wire (s) at the ignition switch. Verification: These wires will register voltage in all positions of the ignition switch. Connect the Red w/White wire to the vehicle's battery wire. This wire provides power for the control circuit as well as the ignition 1 and ignition 2 relays.

5 YELLOW Wire: Starter Output

Careful consideration for the connection of this wire must be made to prevent the vehicle from starting while in gear. Understanding the difference between a mechanical and an electrical Neutral Start Switch will allow you to properly identify the circuit and select the correct installation method. In addition you will realize why the connection of the safety wire is required for all mechanical switch configurations.

Failure to make this connection properly can result in personal injury and property damage.

In all installations it is the responsibility of the installing technician to test the remote start unit and ensure that the vehicle cannot start via RF control in any gear selection other than park or neutral.

In both mechanical and electrical neutral start switch configurations, the connection of the Yellow wire will be made to the low current start solenoid wire of the ignition switch harness. This wire will have +12 volts when the ignition switch is turned to the start (crank) position only. This wire will have 0 volts in all other ignition switch positions.

NOTE: This wire must be connected to the vehicle side of the starter cut relay (when used). For the electrical neutral switch configuration, this connection must be made between the starter inhibit relay, (when used) and the neutral safety switch as shown in the following diagram.

Failure to connect this wire to the ignition switch side of the of the neutral safety switch can result in personal injury and property damage.

SEE NEUTRAL START SAFETY TEST FOR FURTHER DETAILS.

YELLOW START WIRE DETAIL

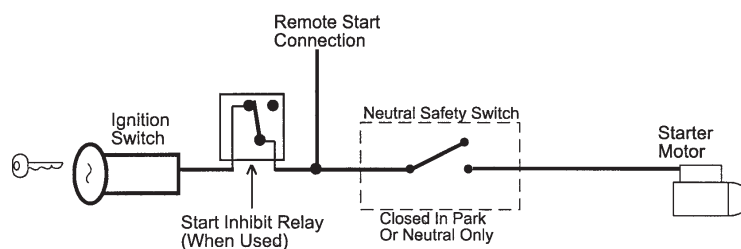

6 GREEN Wire: Ignition 2 Output

Connect this wire to the ignition 2 wire from the ignition switch. This wire will show + 12 volts when the ignition key is turned to the "ON" or "RUN" position and is some cases the "START" or CRANK" position. This wire will show 0 volts when the key is turned to the "OFF" and "ACCESSORY" positions.

NOTE: See programming information (Bank 3 Selection #2) concerning this wire to allow output during the "START" mode.

WIRING CONNECTIONS: 12 Pin Accessory Input/Output Harness**PART # 1123751****1 Yellow/Black Wire: + 12 Volt Alarm By - Pass Output**

NOTE: You must disconnect the ignition input of the alarm from any other wire that it is presently connected to in the vehicle.

This wire provides a + 12 Volt output when the ignition key is turned to the "ON" position, and 0 Volts when the ignition key is "OFF" or when the vehicle is running under the control of the remote starter.

This wire should be connected to the ignition input of the alarm system.

This output will allow you to remote start the vehicle while leaving the alarm armed, and to lock/unlock the doors while running under control of the remote start unit.

2 Green w/ Orange Wire: Tachometer Input Signal

This wire will continually monitor the engine's tach rate while the unit is under power of the Remote Start module. This wire will be routed to the vehicle ECM tach input or through the firewall into the engine compartment and connect to the negative side of the ignition coil. This Remote Start unit learns the tach rate of the vehicle and in most cases will operate properly from one multi coil pack regardless of the number of cylinders. If the vehicle has a single coil unit for each cylinder, it may be necessary to connect this wire to more than one cylinder for proper tach reference. See Multi Coil Pack Adaptor wiring detail shown later in this manual for additional information.

NOTE: For Hybrid mode selection, Bank 3 feature selection 5, this connection is not required, the unit will start the vehicle and run the allotted time based on feature selection and crank duration.

3 Black Wire: Chassis Ground Source

Connect the Black wire to a known vehicle ground source or to a solid clean metal part of the chassis. Be certain to remove any paint or grease and secure this wire with a self tapping screw and ring terminal.

4 Gray w/ Black Wire: Negative Inhibit Input 2

Any time the gray w/ black tracer wire is grounded, the Remote Starter will stop operating, even if the signal is received from the transmitter.

If the brake light switch in the vehicle switches ground to the brake light circuit, connect the Gray w/ Black trace wire to the output of the brake light switch. If the brake light switch in the vehicle switches +12 Volts, do not use the Gray w/ Black wire; see Brown w/ Black tracer wire.

5 Light Blue Wire: Ignition 3 / Ground While Running Output

This wire provides a 300mA ground output that becomes active 3 seconds before the Remote Start Unit initializes, and remains grounded while running plus an additional 2 seconds after the Remote Start Ignition 1 turns off. In all of the applications described below, a relay will be required. The Light Blue wire can be used to accommodate the following situations:

A. Shock Sensor By Pass:

If there is Shock Sensor used with an alarm system and it is not shunted during the Remote Start activation period, then vibration from the running vehicle can cause the alarm to trigger. In this case, connect the Light Blue Wire to terminal #86 of a external relay. Connect terminal #85 of the relay to a fused + 12 volt battery source. Cut the shock sensor trigger wire and connect one end of the cut wire to terminal #30 and the other end of the cut wire to terminal #87a. Just before the Remote Start unit is activated, the relay contacts will open, preventing the shock sensor's operation until the Remote Start unit shuts off.

B. Ignition 3 Output:

Some newer vehicles use a third ignition wire, which is required to start and keep the vehicle's engine running. If this is the case, connect the Light Blue wire to terminal #86 of an external relay. Connect terminal #30 & #85 to a fused + 12 volt battery source rated for a minimum of 25 Amp. Connect terminal #87 to the third ignition wire in the vehicle.

C. GM VATS Key Override:

If the vehicle has the General Motors VATS system installed, you will need to bypass the system while the vehicle is operating under the control of the Remote Start Unit. To Do This;

1. Measure the resistance of the resistor pellet on the ignition key then select a resistor within 5% of the key's value from the resistor pack supplied.
2. Locate the pair of VATS wires in the vehicle, usually a pair of thin gauge wires running from the ignition switch to the VATS control module.

NOTE: These wires are typically White w/ Black trace and Violet w/ Yellow trace, however in later model Cadillacs, they are run through an orange sleeve, and are either both Black, both Yellow, or both White wires. Consult the factory service manual for additional information.

3. Connect the Light Blue Wire from the Remote Start Unit to terminal #86 of an external relay. Connect terminal #85 of the relay to a fused + 12 volt battery source.
4. Cut (#1) wire (as shown), and connect the ignition switch side of the cut wire to terminal #87a of the relay. Connect the other side of the (#1) wire to terminal #30.
5. Connect the previously selected resistor from terminal #87 to the second (#2) wire (as shown).

NOTE: The above information and following diagram is for the GM VATS system only.

6 Green/Yellow Wire: Diesel Wait To Start Input

The Green/Yellow wire of the 12 pin connector will connect to a diesel vehicles glow plug wire. When the unit receives a start command, this wire must go to +12 then to ground to allow the crank sequence to begin. When ignition #1 is activated by the remote start unit, the glow plug circuit gets energized, (+12 volts), when the glow plug circuit of the vehicle drops the +12 volts, which effectively grounds the wait to start input, then 500mS later the starter will engage. This wire can also be connected to the Glow Plug Bulb wire in the vehicle if this bulb wire gets +12 volts when the ignition comes on and drops low when the glow plug circuits temperature is reached. Be sure to fuse the wire with a 1 Amp fuse when connecting to a high current circuit such as a factory glow plug wire. The fuse should be installed as close to the high current wire as possible. If you are installing this unit in a Gasoline vehicle, this wire is not used.

7 Gray Wire: Negative Inhibit Input 1

Connect the GRAY wire to the previously mounted hood pin switch provided. This wire will be routed through the firewall into the engine compartment. It is necessary to use an existing grommet when passing wires through the firewall to prevent short circuiting. This is an important safety feature of the System, failure to use this feature can result in serious injury. Route the wire to the pin switch and connect it using the bullet connector provided.

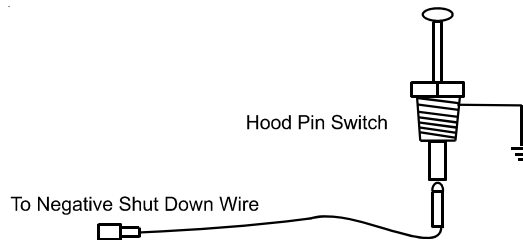

8 Brown Wire: Positive Inhibit Input 1

Any time + 12 Volts is applied to the Brown wire, the Remote Starter will stop operating, even if the signal is received from the transmitter.

If the vehicle has a factory installed hood pin switch and that switch provides + 12 Volts to an under hood light, the Brown wire can be connected to the existing pin switch.

9 Brown w/ Black Wire: Positive Inhibit Input Plus Trigger When Armed

The Brown w/ Black Trace wire provides an instant shutdown for the Remote Start Control module whenever it gets + 12 volts also triggers the alarm when armed. If the Brake lights switch in the vehicle switches + 12 volts to the brake light circuit, connect the Brown w/ Black trace wire to the output side of the brake switch. This will allow the Remote Start to shut down if an attempt is made to operate the vehicle without the key while running under the control of the Remote Start. In most vehicles, in order to shift into gear, the brake pedal must be depressed. The brake input will in turn cause the remote start unit to shut off.

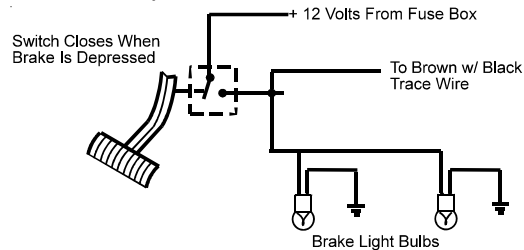

10 No Connection

11 White Wire: Parking Light Flasher Output

This wire is the normally open contact of the on board parking light flasher relay. Connect this wire to the vehicle's parking light feed wire. This is the wire that gets switched on, either (+) or (-), when the vehicle's parking light switch is activated.

12 White Wire: Parking Light Flasher Input

This wire is the common contact of the on board parking light flasher relay. If the vehicle you are working on has +12 volt switched parking lights, connect this wire to a fused +12 volt source. (Max. 15 Amps)

NOTE: If the vehicle's parking lights are ground switched, connect this wire to chassis ground.

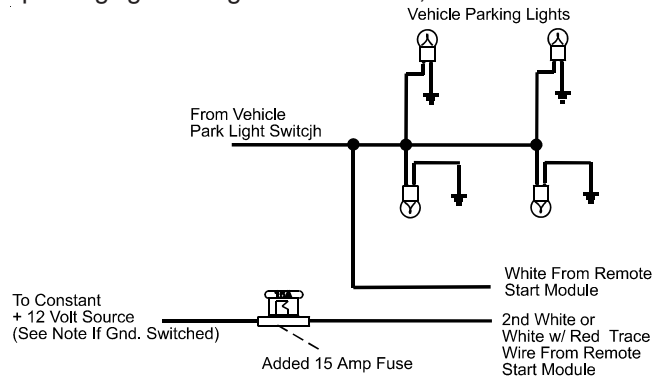

WIRING THE 4 PIN AUXILIARY OUTPUT HARNESS**Part #1122585**

The auxiliary 4 pin connector provides low current outputs to control various functions in the vehicle during different stages of the Remote Start unit's operation. Understanding these outputs and the time in which they occur will allow you to determine if they are needed for the particular vehicle you are working on as well as how to use them.

1 Black w Blue Trace Wire: Pulsed Ground Output Before Start

The Black w/ Blue Trace wire will provide a 1 second 300 mA pulsed ground output 1.5 second before the remote start unit activates as well as when the transmitter is used to disarm the system. Typical use for this output would be to disarm a factory theft deterrent system to prevent false triggering of the factory alarm when the remote start unit engages or when the system is used to unlock the doors. This will also activate when the transmitter is used to disarm/unlock the system

NOTE: This output can be selected to operate like the door lock output as set in alarm feature setting #1 by selecting feature #17 in Bank 3 for 2 Chirps.

2 Black w/ Light Green Trace Wire: Pulsed Ground Output After Start

The Black w/ Light Green Trace wire will provide a 1 second 300mA pulsed ground output after the vehicle is started under control of the remote start unit. Typically this wire will be used to re-lock the vehicle doors if the doors unlock automatically when the factory anti-theft system is disarmed. This wire will also activate when the transmitter is used to arm/lock the system.

3 Black w/ Red Trace Wire: Pulsed Ground Output After Shutdown

The Black w/ Red Trace wire will provide a 1 second 300 mA pulsed ground output after the remote start unit shuts down. This output will occur regardless of whether the circuit times out or is manually terminated. Typically this output will be used to re-lock the vehicle doors if the doors unlock automatically when the ignition circuit transitions to off.

4 Black w/ Yellow Trace Wire: Ground Output During Start (Crank)

The Black w/ Yellow Trace wire will provide a 300 mA ground output while the starter output of the remote start unit is active. This output can be used to activate the Crank Low/Bulb Test wire found in some GM vehicles. This wire is also referred to as the ECM wake up wire in some vehicles.

NOTE: The outputs above are low current outputs and must be used with a relay if the circuit's requirement is more than 300 mA.

5 Wire Antenna/Receiver Program Push-Button Switch/LED Connector: Part # 1123906

Plug the previously routed antenna connector from the antenna receiver assemble into the mating connector of the control module. This connector supplies 12 volts, ground and RF data input, LED Cathode, and Valet Enable to and from the antenna receiver and the remote start module. Be certain these connectors are firmly seated making good contact to the control unit.

2 Pin Transponder Control Output: (Yellow Connector)**Part # 1122392**

a: When selected for while remote start on, the black wire will be active at the same time ign. 3 becomes active, and will remain active all the time the unit is operational under the control of the remote start.

b: When selected for output during the start sequence, the black wire will be active at the same time Ign. 3 becomes active, and will remain active until the vehicle has started. This will be used for one time read transponder circuits.

c: When the unit is selected for until ignition off, the black wire will become active at the same time ign. 3 becomes active and will remain active even after the key take over and until the ignition in the vehicle is turned off. This will allow the unit to be used for continuous read transponders circuits.

1 Black: 250mA Output (-)

The black wire switches on when the remote start is activated and will stay on as programmed in the remote start feature Bank 3 Feature 12.

2 Red: 250mA Output (+) 12 Volts Constant

This output is intended to allow the control of a transponder bypass interface module or transponder bypass relay.

Monitoring The Vehicle's Engine:

(Program Feature #5 Bank 3)

There are 4 ways that the remote start monitors the engine running, one or the other must be selected for your application for the remote start to operate correctly.

1) VOLTAGE SENSE SETTING:

The unit will monitor the voltage level of the battery during remote start, wait for the voltage to drop while cranking, then look for the voltage level to go above the level it was before the vehicle began to crank which indicates the vehicle is running. Feature #14 of Bank 3 must be set for preset time or the voltage sense feature will not operate indicated by the parking lights flashing 7 times.

2) TACH RATE SETTING:

1. Turn the ignition key to the On position.
2. Press and release the valet/program push button switch 3 times.
3. Immediately turn the ignition key Off.
4. Press and hold the valet/program push button switch, then start the vehicle using the key.
5. When the unit senses the tach signal, the parking lights will begin to flash.
6. Release the valet/program pushbutton switch. The parking lights will turn on for three seconds to indicate that the learned tach signal is stored and the unit is out of the tach learn mode.

NOTE: If the unit fails to learn tach rate due to an improper tachometer connection or a poor tach source, the parking lights will not flash. To correct this situation, locate and connect the Green/Orange wire to the proper tach signal, and then repeat the tach learn routine.

3) DBI TACH SETTING:

Selecting this setting in the option menu indicates that you have a DBI module and have determined that a tach signal is available for the vehicle you are connecting to. The unit will look at the DBI data port for the tach signal. If the vehicle fails to start, or the unit flashes 7 times, recheck the DBI manual to insure that tach is available for your vehicle. If not the tach connection wire, Green/Orange must be used.

4) HYBRID SETTING:

Selecting this setting in the option menu allows for Hybrid vehicles. Also feature #14 of Bank 3 must be set for preset time or the Hybrid feature will not operate indicated by the parking lights flashing 7 times.

CRANK AVERAGING:

When Feature 14 Bank 3 is set for crank averaging, the remote start unit constantly monitors and learns the cranking patterns of the vehicle each time the car is started with the key. The vehicle must be started atleast 4 times with the key for the crank averaging circuit to begin it's monitoring the vehicle's engine.

DIAGNOSTICS:

Enter Bank 3 and turn on selectable feature # 9 as described on the front pages of this manual.

NOTE: Diagnostic mode is a temporary mode. Once you have accessed the diagnostic mode, the unit will pause for two seconds then begin to flash the last stored shut down code. This code will be displayed three times in succession, then the unit will automatically exit the diagnostic on mode.

The parking lights will flash a number of times indicating the reason for the last remote start shutdown. The light flash indications are as follows:

- | | |
|-----------|--------------------------------------------------------------------------------|
| 1 Flash | Run timer expired |
| 2 Flashes | Low or no tach signal (RPM) |
| 3 Flashes | Positive inhibit wire activation |
| 4 Flashes | NA |
| 5 Flashes | RF shutdown, Remote signal received, or manual start trigger wire reactivated. |
| 6 Flashes | High tach signal (RPM) |
| 7 Flashes | Tach signal has not been learned |
| 8 Flashes | Negative inhibit wire |

Multi Coil Pack Adaptor: (Optional)

The multi coil pack adaptor, is designed for use with vehicles that do not respond to single coil tach programming. Although the tach resolution of this circuit is designed to interface direct with most vehicles, there may be an occasion where the following circuit may be required. Construct the adaptor as shown below.

To use the adaptor, the Green/Black wires must connect to the negative side of the ignition coil(s).

1. For vehicles utilizing independent coils per cylinder, connect the three Green/Black leads to alternate coils. To achieve optimum performance the coil signals must be evenly distributed. This is accomplished by first mapping out the firing order of the engine in groups of as indicated below. Draw a circle around any of the columns. The Green/Black wires should be connected to the negative (-) terminal of the respective cylinder number which appears in any of the circles.
2. For vehicles utilizing 2 cylinder firing per coil pack, connect Green/Black to the tach side of each coil pack. For 8 cylinder, four coil systems, connect to any of the three coils.
3. Connect the Yellow wire to a +12 volt ignition 1 source. This wire will have +12 volts with the ignition in the on and start position and have 0 volts with the ignition in the off position.
4. Connect the Green wire to the (Green) or (Orange/Green) tach input of the Audiovox remote start unit.

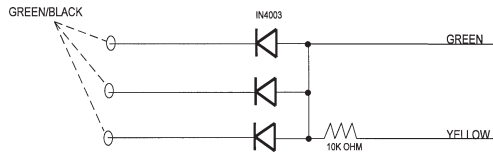

IF THE FIRING ORDER IS 1,8,4,3,6,5,7,2

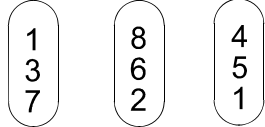

CONNECT TO CYLINDERS 137, OR 862, OR 451

IF THE FIRING ORDER IS 1,5,6,3,4,2,7,8

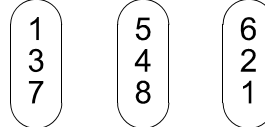

CONNECT TO CYLINDERS 1,3,7 OR 5,4,8 OR 6,2,1

TESTING YOUR INSTALLATION:

WARNING!! The following procedure must be performed after the installation of any Remote Start Device. It is the responsibility of the installing technician to complete these tests. Failure to test the unit in the following manner may result in personal injury, property damage, or both.

HOOD PIN SAFETY SHUT DOWN:

The intent of the hood pin safety shut down is to prevent the Remote Start unit from being activated while a mechanic or vehicle owner is performing normal routine vehicle maintenance.

To test the integrity of this circuit:

1. With the drivers window in the down position, start the vehicle using the RF transmitter.
2. Reach inside the car and pull the hood release.
3. Raise the hood and confirm that the remote start unit shuts down.

If the unit fails this test, recheck your pin switch connection to the Gray/Black wire of the Remote Start Unit.

DO NOT RELEASE THIS VEHICLE TO THE CONSUMER UNTIL YOU CONFIRM THE OPERATION OF THE HOOD PIN SAFETY SHUT DOWN FEATURE.

REMOTE START OVERRIDE MODE / MANUAL SHUT DOWN:

The intent of the remote start override / manual shut down circuit is to allow the vehicle operator to prevent operation of the Remote Start Unit regardless of the RF transmitter operation.

To Enter The Remote Start Override Mode:

- 1) With the system disarmed/unlocked, and the ignition switch off Press and Hold the pushbutton switch located on the receiver unit on.
- 2) Turn the ignition switch on, off, on, off, on, off.
- 3) The LED begins to flash two short flashes followed by one long flashes and continues this pattern until returned to normal mode of operation.

The action above puts the unit into the Remote Start Override mode or vehicle service mode and will not start from the RF transmitter or any other input.

To Exit Remote Start Override Mode:

- 1) With the system disarmed, Press and Hold the PBLed on.
- 2) Turn the ignition switch on, off, on, off, on, off.
- 3) The LED turns off indicating that the R/S unit is fully functional one again.

DO NOT RELEASE THIS VEHICLE TO THE CONSUMER UNTIL YOU CONFIRM THE OPERATION OF THE MANUAL SHUT DOWN / ENABLE FEATURE.

NEUTRAL START SAFETY TEST:

The intent of the neutral start switch is to prevent the vehicle from starting while the gear selector is in any position other than Park, or Neutral. When installing a Remote Start Device, it is imperative that the Yellow Starter wire be connected to the ignition switch side of the Neutral Start Switch. Consideration for the placement of a starter inhibit relay is important as well and should be connected to the ignition switch side of the Yellow Start Wire.

To test the integrity of the Neutral Start Safety Circuit:

- 1) Set the vehicle parking brake.
- 2) Block the drive wheels to prevent vehicle movement.
- 3) Temporarily disconnect the Brown/Black positive shut down wire from the vehicle's brake switch.
- 4) Sitting in the vehicle, start the engine using the vehicle's ignition key.
- 5) Step on the brake pedal and shift the gear selector into reverse.
- 6) Allow the transmission to shift. When you feel the engine pull, do not move the gear selector just turn the ignition switch off. DO NOT attempt to remove the key.
- 7) Keeping the brake pedal depressed, activate the RF transmitter in an attempt to start the vehicle. The car should not start.
- 8) Repeat the above test this time move the gear selector to the drive position.

If the unit attempts to start, failing this test, recheck your Yellow Wire's connection. This wire must be connected to the ignition switch side of the Neutral Start Switch. If the vehicle you are working on does not have an Electrical Neutral Safety Switch, it will be necessary to reconfigure the Remote Starts Wiring to accommodate the vehicle. The information concerning the Mechanical Neutral Safety Switch provided below will help you to determine if the vehicle you are working on has this type of safety switch and will provide alternate wiring methods to accommodate this situation.

**CAUTION! REMEMBER TO RECONNECT THE BROWN/BLACK NEUTRAL SAFETY WIRE
TEMPORARILY DISCONNECTED IN STEP 3**

MECHANICAL NEUTRAL SAFETY SWITCH CONSIDERATIONS:

Mechanical neutral safety switch configurations differ slightly in that they do not offer the same level of safety when installing a remote start device. Often when the ignition switch is turned off while the gear selector is in any position other than park or neutral, the mechanical function will not allow the key to be turned to the start position or be removed from the ignition cylinder. This configuration prevents mechanical operation while the vehicle is in gear but offers no consideration for electrical operation. Because of this potential problem, this installation requires the additional connection of a safety wire from the remote start device to the vehicle Park/Neutral ECM Input or the vehicle key in sensor. This connection will prevent remote start operation if the key is left in the ignition switch regardless of the gear selectors position.

**DO NOT RELEASE THIS VEHICLE TO THE CONSUMER UNTIL YOU CONFIRM THE OPERATION OF
THE MECHANICAL NEUTRAL SAFETY START FEATURE.**

KEY IN SENSOR CIRCUITS:

If the vehicle you are working on does not have or you cannot locate the ECM reference wire, there are two alternatives available. Although not preferred, the vehicle Key In Sensor may be reconfigured to allow a margin of safety and will prevent the vehicle with a Mechanical Neutral Start Switch from starting in gear. AUDIOVOX ADVISES THAT YOU MAINTAIN THE FACTORY CIRCUIT WHENEVER POSSIBLE. The following two circuits may be used only if the above circuit is not available.

NOTE: When completing an installation using either of the following key in sensor circuits, if the operator inserts the ignition key while the vehicle is running under the control of the Remote Start, the vehicle will shut down. This must be explained to the operator as it is in contrast to the normal operation of a vehicle utilizing an electrical neutral start switch and is inconsistent with the operators manual. Additional information concerning Key In Sensor methods 1 and 2 are listed below and should be reviewed before considering either alternative.

Method 1 will allow the safety required for the remote start unit and prevent the vehicle from starting while in any gear other than Park or Neutral while the key is in the ignition cylinder however, if the key is left in the ignition switch and the door is left opened, the added relay will be energized causing a 150mA drain on the battery.

Method 2 will allow the safety required for the remote start unit and prevent the vehicle from starting while in any gear other than Park or Neutral while the key is in the ignition cylinder however, the original factory key in chime module will not alert the owner that the key has been left in the ignition switch. In addition, this may also effect other warning tones such as the light on reminder.

These situations should be carefully considered before altering the vehicle's wiring and must be fully explained to the consumer.

METHOD 1

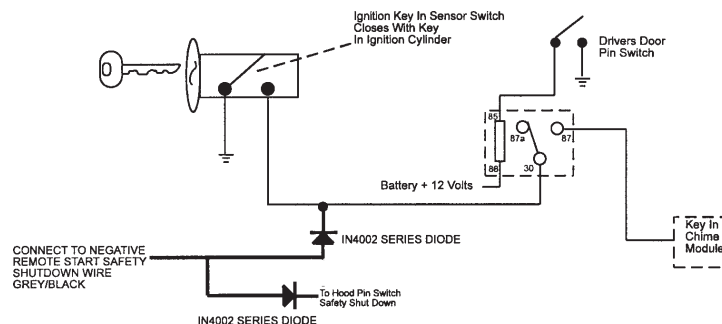

To connect to the key in sensor as shown in method 1:

- 1) Locate the control wire that connects the drivers door pin switch to the key in sensor switch.
- 2) Cut this wire and connect the ignition cylinder side to chassis ground.
- 3) Locate the key in sensor switch wire that connects the chime module to the ignition cylinder .
- 4) Cut this wire and connect the ignition cylinder side to terminal 30 of a P&B VF45F11 or equivalent relay.
- 5) Connect the cathode (striped) side of a 4002 series diode to this same wire, and connect the (non striped) side to the negative shut down safety wire (Gray / Black) of the Audiovox Remote Start Unit.
- 6) Connect terminal 86 of the relay to a fused +12 volt constant battery source.
- 7) Connect terminal 87 of the relay to the Chime Module side of the previously cut wire in step D.
- 8) Connect terminal 85 of the relay to the Drivers Door side of the pin switch wire previously cut in step B.

NOTE: A second 4002 series diode may be required to maintain the integrity of the hood open, shut down circuit. If this is the case, it must be installed as shown in the diagram above. The anode (Non Striped) side must be connected to the Gray/Black wire of the Remote Start Unit. The cathode (Striped) side must be connected to the hood pin switch. If the hood pin switch is also used for an alarm trigger input, be certain to use the dual diode set up shown earlier in this manual.

METHOD 2:

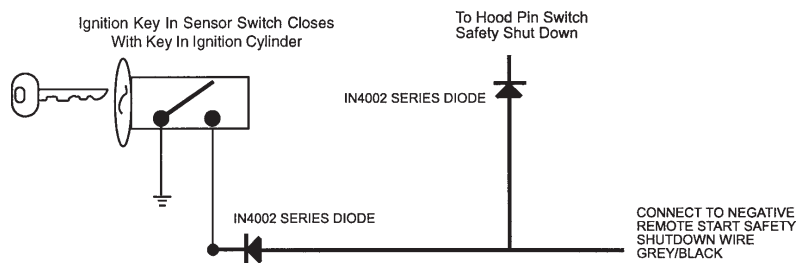

To connect to the key in sensor circuit as shown for method 2:

- 1) Locate the control wire that connects the drivers door pin switch to the key in sensor switch.
- 2) Cut this wire and connect the ignition cylinder side to chassis ground.
- 3) Locate the key in sensor switch wire that connects the chime module to the ignition cylinder .
- 4) Cut this wire and connect the ignition cylinder side to the Remote Start Negative Safety Shut down Wire Gray/Black, using a 4002 series diode as shown above.

NOTE: A second 4002 series diode may be required to maintain the integrity of the hood open, shut down circuit. If this is the case, it must be installed as shown in the diagram above. The anode (Non Striped) side must be connected to the Gray/Black wire of the Remote Start Unit. The cathode (Striped) side must be connected to the hood pin switch. If the hood pin switch is also used for an alarm trigger input, be certain to use the dual diode set up shown earlier in this manual.

AFTER THE CONNECTION OF THE NEUTRAL START SAFETY WIRE AS INDICATED IN ANY OF THE PREVIOUS ALTERNATE CONFIGURATIONS, THIS CIRCUIT MUST BE TESTED FOR PROPER OPERATION.

Retest by following the steps outlined in the NEUTRAL START SAFETY TEST section of the manual.

COMPLETING THE INSTALLATION

- 1) Mount the control module up and behind the dash securing it in place with cable ties or screws. Be certain that the chosen mounting location will not inhibit any of the controls of the vehicle.
- 2) Securely harness and tie all wiring up and away from all hot and moving parts that they may come in contact with under the dash board or in the engine compartment areas.

CAUTION: Particularly avoid the area around the steering shaft and column, as wires can wrap around these mechanisms and impair the safe operation of the vehicle.

- 3) Apply the Caution Labels supplied with this kit to a conspicuous area in the engine compartment. Make sure to clean the surface before affixing the label.
- 4) Check the vehicle's wipers, lights, horn, etc.... to insure proper operation.
- 5) Replace all panels that were removed during installation, and retest the system.
- 6) Explain all activated features and safety systems associated with the Remote Start Unit installed. Also point out the location of the Push-Button LED Override/Valet switch to the customer and explain it's operation.

The transmitters are pre-programmed from the factory, If you find you need to program new or additional transmitters follow the instructions below.

PROGRAMMING BANK 1 (TRANSMITTERS):

- 1) Turn the ignition key to the on position.
- 2) Press and release the valet/programming switch 3 times. (Siren Chirps)
- 3) Press the Button of each transmitter you want programmed until you hear the parking light relay click.
- 4) Turn the ignition switch off.

The above action programs the Start/Unlock buttons of the system.

PROGRAMMING BANK 2 (ALARM FEATURES):

You can enter bank 2 from bank 1 by turning the ignition key off then on from step 4 of Bank 1. (Siren Short then Long Chirp), or You can also go right to bank 2 by:

- 1) Turn the ignition key to the on position.
- 2) Press and release the valet/programming switch 3 times. (Siren Chirps)
- 3) Turn the ignition key off then on. (Siren Short Then long Chirp)
- 4) Press the pushbutton switch once to advance to feature 1, twice to advance to feature 2, etc.,,then use the lock button of the transmitter to select the feature setting.

Example to set door lock output to double lock & unlock pulse:

- 1) Turn the ignition key to the on position.
- 2) Press and release the valet/programming switch 3 times. (Siren Chirps)
- 3) Turn the ignition key off then on. (Siren Short Then long Chirp)
- 4) Press the pushbutton switch once to advance to features 1, Door Lock/Unlcok Timing, then use the lock button of the transmitter to select five chirps "DbL L, DBL U/L".
- 5) To exit the programming mode, turn the ignition key off. The program mode is automatically exited when there is no activity on the pushbutton switch or the transmitter lock button.

SELECTABLE FEATURES

The selectable features of this unit can be set manually as explained on the previous page or with the RF feature programmer described in the guide packaged with the programmer. Factory default settings are indicated by **BOLD** text.

Note : The method of manual override can either be selected to operate from the valet switch or operate by custom code. Custom Code programming is found in the owners guide.

Be certain to place a check mark indicating the method used in the box located on the last page of the owner's manual.

NOTE: Keyless Entry Models with no horn output will Flash the Parking Lights instead of chirp where chirp is indicated. Also, No data will be indicated if a feature is not available for a particular model. The unit will enter the feature but no selection will be available.

RF Programmable Feature Bank 1 Is For Transmitter Programming See Transmitter Programming Guide.

RF Programmable Features Bank 2 Is Alarm Selectable Features:

| | | | | | | |
|-----------------------|---------------|----------|-------------------|------------------|----------------|----------------|
| Feature Selection | 1 Chirp | 2 Chirps | 3 Chirps | 4 Chirps | 5 Chirps | 6 Chirps |
| 1st Door/L/U/L | 1 Sec. | 3.5 Sec. | 1 Sec L, Dbl. U/L | Dbl L, 1 Sec U/L | Dbl L, Dbl U/L | 1 S I/350mS ul |
| 2nd Accy Lock | Not Available | | | | | |
| 3rd Accy. UL | Not Available | | | | | |
| 4th Headlights | Not Available | | | | | |
| 5th Passive Locks | Not Available | | | | | |
| 6th Pass/Act Arm | Not Available | | | | | |
| 7th Siren/Horn | Not Available | | | | | |
| 8th Horn Chirp | Not Available | | | | | |
| 9th O/R Method | Not Available | | | | | |
| 10th 2 Step U/L | Not Available | | | | | |
| 11th Chp Del Tx | Not Available | | | | | |
| 12th Volts/HdWire | Not Available | | | | | |
| 13th Trigger Circuits | Not Available | | | | | |
| 14th L/U/L Poll | Not Available | | | | | |
| 15th Aux Ch 5 Sel | Not Available | | | | | |
| 16th Aux Ch 6 Sel | Not Available | | | | | |
| 17th Aux Ch 7 Sel | Not Available | | | | | |
| 18th Trigger Delay | Not Available | | | | | |

When using the RF programmer, enter the program mode as follows:

Turn the ignition on

Press and release valet switch 3 times

Turn ignition off then on

Press and hold valet switch for 5 seconds

Siren chirps 2 times indicating access to RF feature program mode.

PROGRAMMING BANK 3 (REMOTE START):

You can enter Bank 3 from Bank 2 by turning the ignition key off then on after you've made the changes you wanted in Bank 2, (Siren two Long Chirp), You can also go right to bank 3 by:

- 1) Turn the ignition key to the on position.
- 2) Press and release the valet/programming switch 3 times (Siren Chirps).
- 3) Turn the ignition key off then on. (Siren Short Then long Chirp)
- 4) Turn the ignition key off then on. (Siren two Long Chirp)
- 5) Press the pushbutton switch once to advance to feature 1, twice to advance to feature 2, etc,,,then use the lock button of the transmitter to select the feature setting.

Example to set engine input check to DBI Tach:

- 1) Turn the ignition key to the on position.
- 2) Press and release the valet/programming switch 3 times (Siren Chirps).
- 3) Turn the ignition key off then on. (Siren Short Then long Chirp)
- 4) Turn the ignition key off then on. (Siren two Long Chirp)
- 5) Press the pushbutton switch five times to advance to features 5, Input Check, then use the lock button of the transmitter to select three chirps, "DBI Tach"
- 6) To exit the programming mode, turn the ignition key off. The program mode is automatically exited when there is no activity on the pushbutton switch or the transmitter lock button.

TACH RATE PROGRAMMING:

1. Turn the ignition key to the On position.
2. Press and release the valet/program push button switch 3 times.
3. Immediately turn the ignition key Off.
4. Press and hold the valet/program push button switch, then start the vehicle using the key.
5. When the unit senses the tach signal, the parking lights will begin to flash.
6. Release the valet/program pushbutton switch. The parking lights will turn on for three seconds to indicate that the learned tach signal is stored and the unit is out of the tach learn mode.

NOTE: If the unit fails to learn tach rate due to an improper tachometer connection or a poor tach source, the parking lights will not flash. To correct this situation, locate and connect the Green/Orange wire to the proper tach signal, and then repeat the tach learn routine.

RF Programmable Features Bank 3 Is Remote Start Selectable Features:

Feature Selection 1 Chirp 2 Chirps 3 Chirps 4 Chirps 5 Chirps 6 Chirps

1st Defrost Output

Not Available

2nd RF Start Chirp

Not Available

3rd Run Time

5 Mins

10 Mins

15 Mins

20 Mins

45 Mins

60 Mins

4th Parking Lights

On Steady

Flashing

5th Input Check

Voltage

Tach

DBI Tach

Hybrid

6th Voltage Level

>0.5V B4 Start

< 0.5V B4 Start

7th Ign. 2 Select

Off During Crank

On During Crank Same As Accy.

8th Ign. 3 Select

Not Available

9th Diagnostics

Off

On

10th Crank Time

0.8 Sec

1.0 Sec

1.5 Sec

2.0 Sec

11th Gas/Diesel

Gas

Diesel 10

Diesel 15

Diesel 20

12th Transponder O/P

While R/S On

During Start

Until Ign. Off

13th Temp Start

Not Available

14th Crank Averaging

Averaging

Preset Time

Note: When averaging, the engine must be started

4 times with the key to be effective.

15th R/S Shock

Not Available

16th Turbo Select

Not Available

17th Black/Blue (Aux O/P)

Single Pulse

As Feature #1

18th One or Two Press Start

Two Press

One Press

Note : When feature #5 is set for Voltage or Hybrid, the unit must also have feature #14 set for Preset Time or the unit will flash the parking lights 7 times and not start.

When using the RF programmer, enter the program mode as follows:

Turn the ignition on

Press and release valet switch 3 times

Turn ignition off then on

Press and hold valet switch for 5 seconds

Siren chirps 2 times indicating access to RF feature program mode.

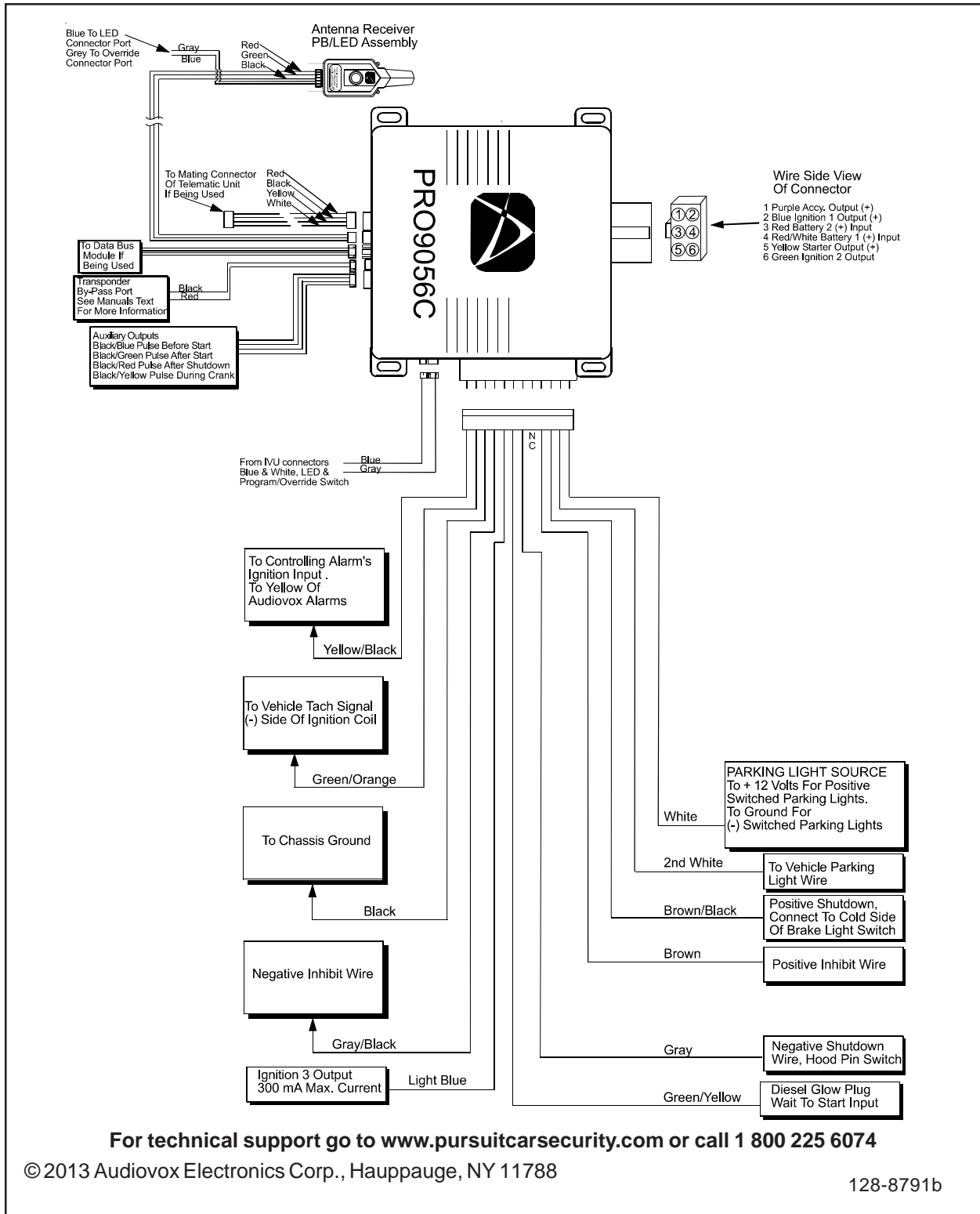

NOTES

NOTES